

- Compact housing to heavy duty applications (only one actuator)
- Degree of Protection IP67 (IEC 60529)
- Pin plunger, roller plunger and sphere actuators
- Internal switch with changeover circuit and rating 5A
- Solder and screw terminals
- Optional LED indicator
- Pg 7 cable entry protection in the housing
- Adjustable actuator (90° rotation)

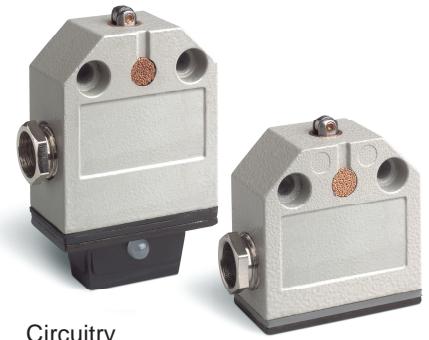

Circuitry
(IEC 60947-5-1)

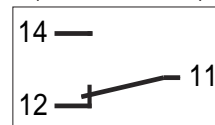

Specifications

Electrical Rating	5A 250Vac
Contact Resistance	50mΩ maximum initial (at 1A 5Vdc)
Ambient Temperature	+85°C maximum
Operating Speed	0,9mm/sec minimum to 1 m/sec maximum (30° cam)
Degree of Protection	IP67 (IEC 60529)
Internal Switch	Circuit Form C (IEC 60947-5-1)
Mechanical Life Expectancy	10.000.000 cycles
Electrical Life Expectancy	50.000 cycles
Materials	Enclosure: Painted Die Cast Aluminium
	Atuadores: Stainless Steel

Ordering Information

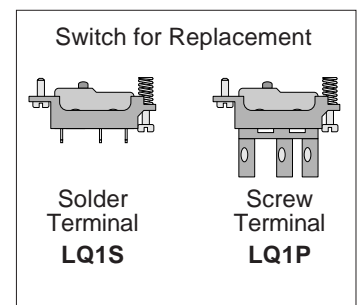
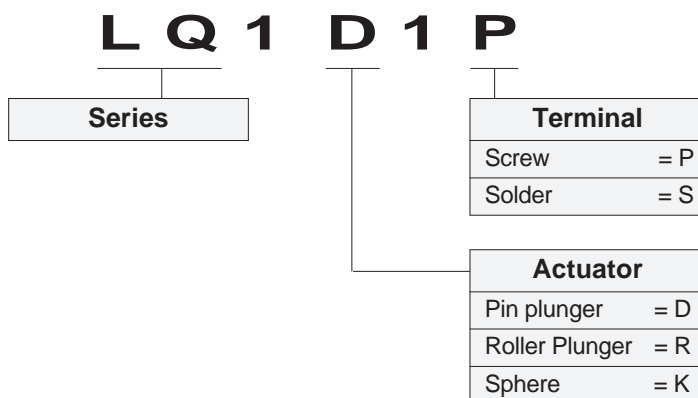

For indicator light with LED, add to the code:

- **Q0** - LED 6Vac/Vdc; **Q1** - 12Vac/Vdc; **Q2** - 24Vac/Vdc; **Q3** - 48Vac/Vdc; **Q5** - 110Vac e **Q6** - 220Vac
- And: **N** for inferior position, **L** for lateral e **F** for frontal

Example: Position switch with pin plunger, solder terminal and LED 110Vac inferior position = **LQ1D1SQ5N**

Dimensions

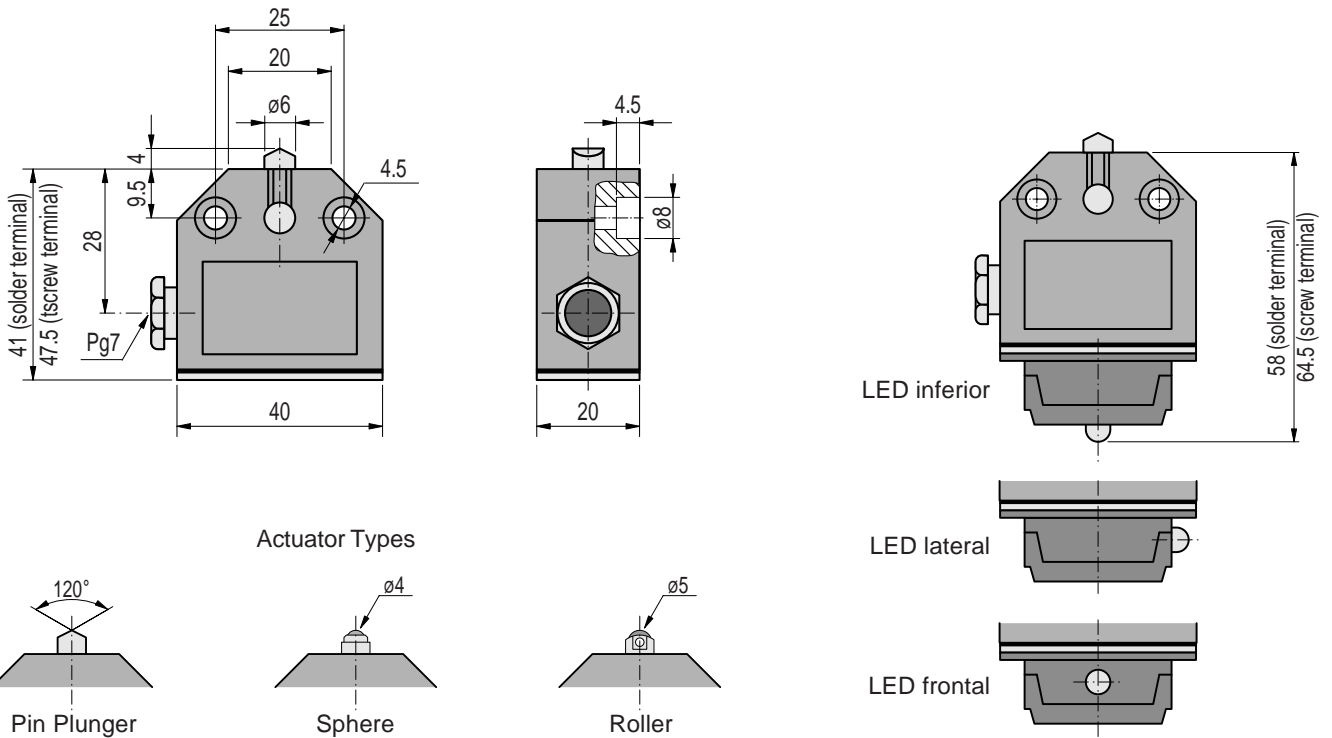

Subject to change without prior notice

Characteristics

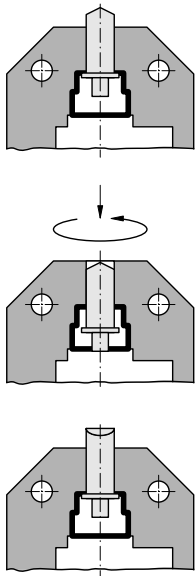

To rotate the actuator:

- 1 - Press totally the actuator.
- 2 - With the actuator pressed, rotate it in 90°
- 3 - Return the actuator to the original position

Course Diagram

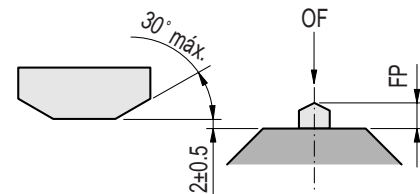
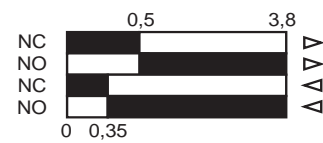

Operating Force (OF)	800g max.
Free Position (FP)	4,0±0,2mm
Operating Position (OP)	3,5±0,2mm
Differential Travel (DT)	0,15mm max.
Overtravel (OT)	2,3mm mín.